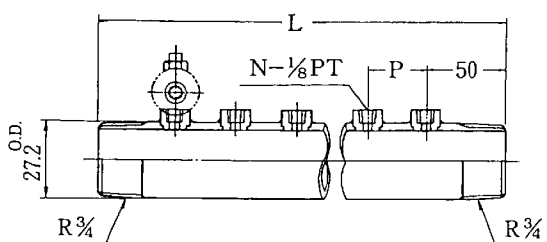

## HP[B]-AS-TYPE

 単位/mm  
 Dimension in mm

※ ヘッダーにはミニチュアバルブ類を含まぬものを標準とします。

※ HEADER items are not attached with Miniature Valves as our standard.

型 式 Type	管用ネジ Pipe thread	L	P	N
	P T			
HP[B]-AS 2	Rc NPT	130	30	2
HP[B]-AS 3	Rc NPT	160		3
HP[B]-AS 4	Rc NPT	190		4
HP[B]-AS 5	Rc NPT	220		5
HP[B]-AS 6	Rc NPT	250		6
HP[B]-AS 7	Rc NPT	280		7
HP[B]-AS 8	Rc NPT	310		8
HP[B]-AS 9	Rc NPT	340		9
HP[B]-AS 10	Rc NPT	370		10
HP[B]-AS 12	Rc NPT	430		12
HP[B]-AS 15	Rc NPT	520		15
HP[B]-AS 17	Rc NPT	580		17
HP[B]-AS 20	Rc NPT	670		20

## HP[B]-BS-TYPE

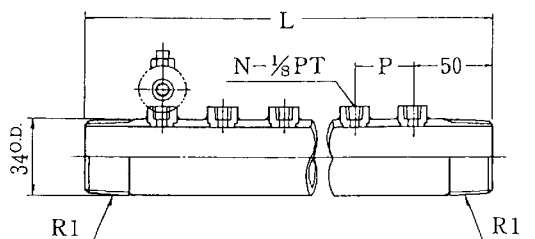
 単位/mm  
 Dimension in mm

※ ヘッダーにはミニチュアバルブ類を含まぬものを標準とします。

※ HEADER items are not attached with Miniature Valves as our standard.

型 式 Type	管用ネジ Pipe thread	L	P	N
	P T			
HP[B]-BS 5	Rc NPT	220	30	5
HP[B]-BS 8	Rc NPT	310		8
HP[B]-BS 10	Rc NPT	370		10
HP[B]-BS 13	Rc NPT	460		13
HP[B]-BS 15	Rc NPT	520		15
HP[B]-BS 18	Rc NPT	610		18
HP[B]-BS 20	Rc NPT	670		20
HP[B]-BS 23	Rc NPT	760		23
HP[B]-BS 25	Rc NPT	820		25

## HP[B]-CS-TYPE

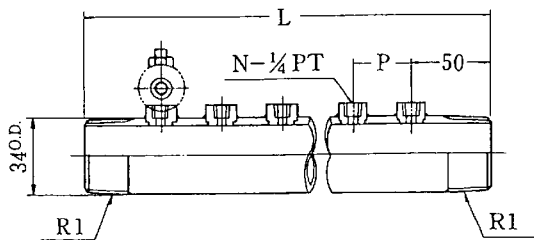

※ ヘッダーにはミニチュアバルブ類を含まぬものを標準とします。

※ HEADER items are not attached with Miniature Valves as our standard.

単位/mm  
Dimension in mm

型式 Type	管用ネジ Pipe thread	L	P	N
	P T			
HP[B]-CS 5	Rc NPT	260	40	5
HP[B]-CS 8	Rc NPT	380		8
HP[B]-CS 10	Rc NPT	460		10
HP[B]-CS 13	Rc NPT	580		13
HP[B]-CS 15	Rc NPT	660		15
HP[B]-CS 18	Rc NPT	780		18
HP[B]-CS 20	Rc NPT	860		20
HP[B]-CS 23	Rc NPT	980		23
HP[B]-CS 25	Rc NPT	1060		25

## HP[B]-DS-TYPE

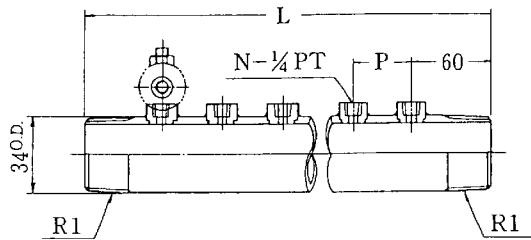

※ ヘッダーにはミニチュアバルブ類を含まぬものを標準とします。

※ HEADER items are not attached with Miniature Valves as our standard.

単位/mm  
Dimension in mm

型式 Type	管用ネジ Pipe thread	L	P	N
	P T			
HP[B]-DS 5	Rc NPT	320	50	5
HP[B]-DS 6	Rc NPT	370		6
HP[B]-DS 8	Rc NPT	470		8
HP[B]-DS 10	Rc NPT	570		10
HP[B]-DS 13	Rc NPT	720		13
HP[B]-DS 15	Rc NPT	820		15
HP[B]-DS 18	Rc NPT	970		18
HP[B]-DS 20	Rc NPT	1070		20
HP[B]-DS 25	Rc NPT	1320		25

## JBH[B]-AS-TYPE

単位/mm  
Dimension in mm

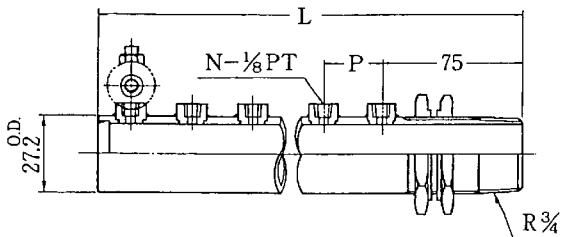
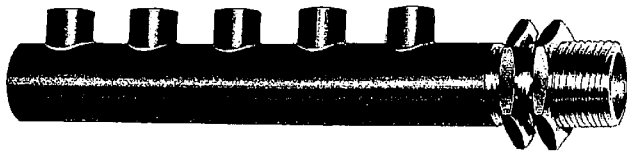

※ ヘッダーにはミニチュアバルブ類を含まぬものを標準とします。

※ HEADER items are not attached with Miniature Valves as our standard.

型式 Type	管用ネジ Pipe thread	L	P	N
	P T			
JBH[B]-AS 2	Rc NPT	125	30	2
JBH[B]-AS 3	Rc NPT	155		3
JBH[B]-AS 4	Rc NPT	185		4
JBH[B]-AS 5	Rc NPT	215		5
JBH[B]-AS 6	Rc NPT	245		6
JBH[B]-AS 7	Rc NPT	275		7
JBH[B]-AS 8	Rc NPT	305		8
JBH[B]-AS 9	Rc NPT	335		9
JBH[B]-AS 10	Rc NPT	365		10
JBH[B]-AS 11	Rc NPT	395		11
JBH[B]-AS 12	Rc NPT	425		12

## JBH[B]-BS-TYPE

単位/mm  
Dimension in mm

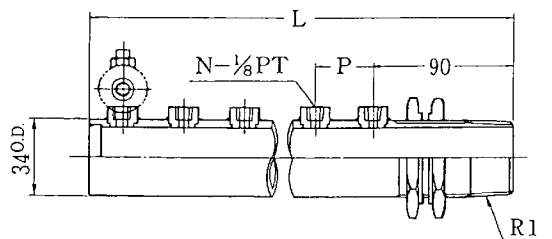

※ ヘッダーにはミニチュアバルブ類を含まぬものを標準とします。

※ HEADER items are not attached with Miniature Valves as our standard.

型式 Type	管用ネジ Pipe thread	L	P	N
	P T			
JBH[B]-BS 5	Rc NPT	230	30	5
JBH[B]-BS 8	Rc NPT	320		8
JBH[B]-BS 10	Rc NPT	380		10
JBH[B]-BS 13	Rc NPT	470		13
JBH[B]-BS 15	Rc NPT	530		15
JBH[B]-BS 18	Rc NPT	620		18
JBH[B]-BS 20	Rc NPT	680		20
JBH[B]-BS 23	Rc NPT	770		23
JBH[B]-BS 25	Rc NPT	830		25

## JBH[B]-CS-TYPE

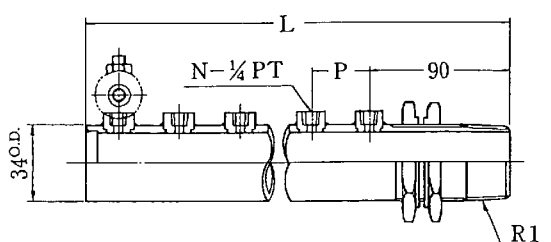

※ ヘッダーにはミニチュアバルブ類を含まぬものを標準とします。

※ HEADER items are not attached with Miniature Valves as our standard.

単位/mm  
Dimension in mm

型式 Type	管用ネジ Pipe thread	L	P	N
	PT			
JBH[B]-CS 5	Rc NPT	270	40	5
JBH[B]-CS 8	Rc NPT	390		8
JBH[B]-CS 10	Rc NPT	470		10
JBH[B]-CS 13	Rc NPT	590		13
JBH[B]-CS 15	Rc NPT	670		15
JBH[B]-CS 18	Rc NPT	790		18
JBH[B]-CS 20	Rc NPT	870		20
JBH[B]-CS 23	Rc NPT	990		23
JBH[B]-CS 25	Rc NPT	1070		25

## JBH[B]-DS-TYPE

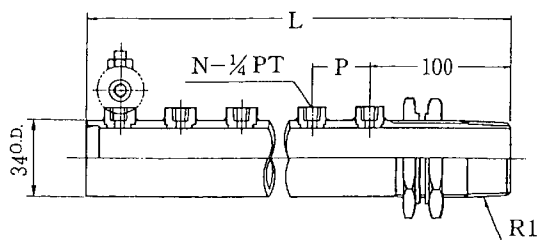

※ ヘッダーにはミニチュアバルブ類を含まぬものを標準とします。

※ HEADER items are not attached with Miniature Valves as our standard.

単位/mm  
Dimension in mm

型式 Type	管用ネジ Pipe thread	L	P	N
	PT			
JBH[B]-DS 5	Rc NPT	330	50	5
JBH[B]-DS 6	Rc NPT	380		6
JBH[B]-DS 8	Rc NPT	480		8
JBH[B]-DS 10	Rc NPT	580		10
JBH[B]-DS 13	Rc NPT	730		13
JBH[B]-DS 15	Rc NPT	830		15
JBH[B]-DS 18	Rc NPT	980		18
JBH[B]-DS 20	Rc NPT	1080		20
JBH[B]-DS 25	Rc NPT	1330		25

## SHP[B]-AS-TYPE

単位/mm  
Dimension in mm

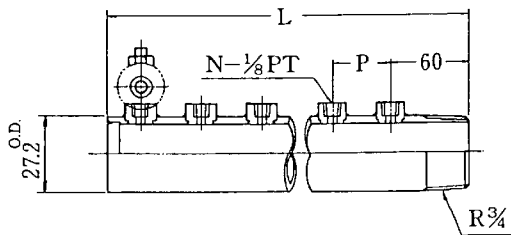

※ ヘッダーにはミニチュアバルブ類を含まぬものを標準とします。

※ HEADER items are not attached with Miniature Valves as our standard.

型 式 Type	管用ネジ Pipe thread	L	P	N
	P T			
SHP[B]-AS 2	Rc NPT	110	30	2
SHP[B]-AS 3	Rc NPT	140		3
SHP[B]-AS 4	Rc NPT	170		4
SHP[B]-AS 5	Rc NPT	200		5
SHP[B]-AS 6	Rc NPT	230		6
SHP[B]-AS 7	Rc NPT	260		7
SHP[B]-AS 8	Rc NPT	290		8
SHP[B]-AS 9	Rc NPT	320		9
SHP[B]-AS 10	Rc NPT	350		10
SHP[B]-AS 11	Rc NPT	380		11
SHP[B]-AS 12	Rc NPT	410		12

## SHP[B]-BS-TYPE

単位/mm  
Dimension in mm

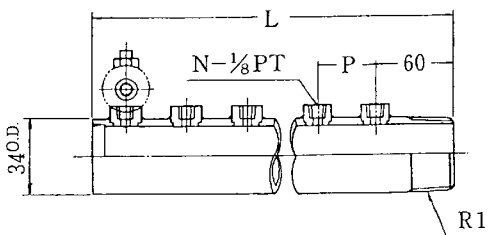

※ ヘッダーにはミニチュアバルブ類を含まぬものを標準とします。

※ HEADER items are not attached with Miniature Valves as our standard.

型 式 Type	管用ネジ Pipe thread	L	P	N
	P T			
SHP[B]-BS 5	Rc NPT	200	30	5
SHP[B]-BS 8	Rc NPT	290		8
SHP[B]-BS 10	Rc NPT	350		10
SHP[B]-BS 13	Rc NPT	440		13
SHP[B]-BS 15	Rc NPT	500		15
SHP[B]-BS 18	Rc NPT	590		18
SHP[B]-BS 20	Rc NPT	650		20
SHP[B]-BS 23	Rc NPT	740		23
SHP[B]-BS 25	Rc NPT	800		25

## SHP[B]-CS-TYPE

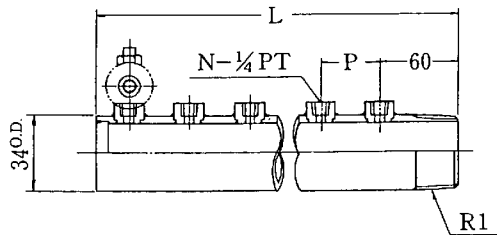

※ ヘッダーにはミニチュアバルブ類を含まぬものを標準とします。

※ HEADER items are not attached with Miniature Valves as our standard.

単位/mm  
Dimension in mm

型式 Type	管用ネジ Pipe thread	L	P	N
	P T			
SHP[B]-CS 5	Rc NPT	240	40	5
SHP[B]-CS 8	Rc NPT	360		8
SHP[B]-CS 10	Rc NPT	440		10
SHP[B]-CS 13	Rc NPT	560		13
SHP[B]-CS 15	Rc NPT	640		15
SHP[B]-CS 18	Rc NPT	760		18
SHP[B]-CS 20	Rc NPT	840		20
SHP[B]-CS 23	Rc NPT	960		23
SHP[B]-CS 25	Rc NPT	1040		25

## SHP[B]-DS-TYPE

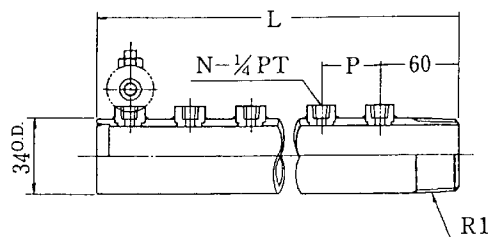

※ ヘッダーにはミニチュアバルブ類を含まぬものを標準とします。

※ HEADER items are not attached with Miniature Valves as our standard.

単位/mm  
Dimension in mm

型式 Type	管用ネジ Pipe thread	L	P	N
	P T			
SHP[B]-DS 5	Rc NPT	290	50	5
SHP[B]-DS 6	Rc NPT	340		6
SHP[B]-DS 8	Rc NPT	440		8
SHP[B]-DS 10	Rc NPT	540		10
SHP[B]-DS 13	Rc NPT	690		13
SHP[B]-DS 15	Rc NPT	790		15
SHP[B]-DS 18	Rc NPT	940		18
SHP[B]-DS 20	Rc NPT	1040		20
SHP[B]-DS 25	Rc NPT	1290		25

## HP-AS-TYPE

単位/mm  
Dimension in mm

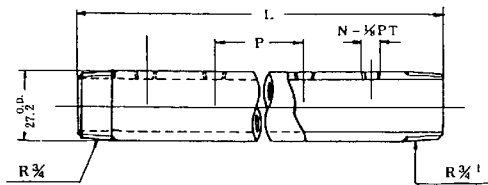

型式 Type	管用ネジ Pipe thread	L	P	N
	P T			
HP-AS 2	Rc NPT	130	30	2
HP-AS 3	Rc NPT	160		3
HP-AS 4	Rc NPT	190		4
HP-AS 5	Rc NPT	220		5
HP-AS 6	Rc NPT	250		6
HP-AS 7	Rc NPT	280		7
HP-AS 8	Rc NPT	310		8
HP-AS 9	Rc NPT	340		9
HP-AS 10	Rc NPT	370		10
HP-AS 12	Rc NPT	430		12
HP-AS 15	Rc NPT	520		15
HP-AS 17	Rc NPT	580		17
HP-AS 20	Rc NPT	670		20

## HP-BS-TYPE

単位/mm  
Dimension in mm

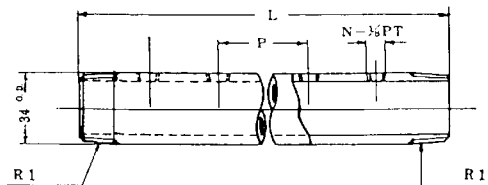
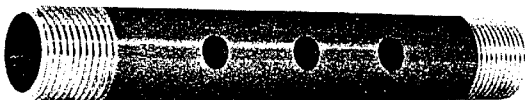

型式 Type	管用ネジ Pipe thread	L	P	N
	P T			
HP-BS 5	Rc NPT	220	30	5
HP-BS 8	Rc NPT	310		8
HP-BS 10	Rc NPT	370		10
HP-BS 13	Rc NPT	460		13
HP-BS 15	Rc NPT	520		15
HP-BS 18	Rc NPT	610		18
HP-BS 20	Rc NPT	670		20
HP-BS 23	Rc NPT	760		23
HP-BS 25	Rc NPT	820		25

## HP-BW-TYPE

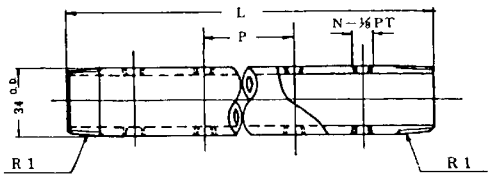
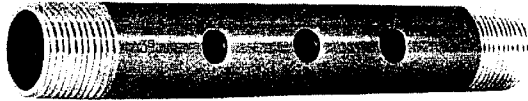

単位/mm  
Dimension in mm

型式 Type	管用ネジ Pipe thread	L	P	N
	PT			
HP-BW10	Rc NPT	220	30	10
HP-BW16	Rc NPT	310		16
HP-BW20	Rc NPT	370		20
HP-BW26	Rc NPT	460		26
HP-BW30	Rc NPT	520		30
HP-BW36	Rc NPT	610		36
HP-BW40	Rc NPT	670		40
HP-BW46	Rc NPT	760		46
HP-BW50	Rc NPT	820		50

## HP-CW-TYPE

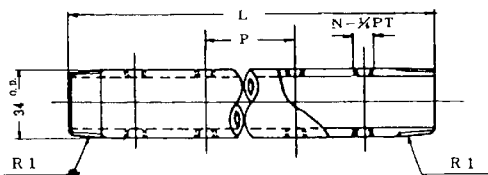
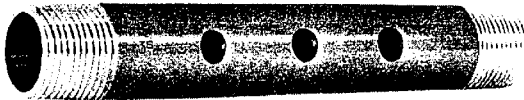

単位/mm  
Dimension in mm

型式 Type	管用ネジ Pipe thread	L	P	N
	PT			
HP-CW10	Rc NPT	260	40	10
HP-CW16	Rc NPT	380		16
HP-CW20	Rc NPT	460		20
HP-CW26	Rc NPT	580		26
HP-CW30	Rc NPT	660		30
HP-CW36	Rc NPT	780		36
HP-CW40	Rc NPT	860		40
HP-CW46	Rc NPT	980		46
HP-CW50	Rc NPT	1060		50



## HP-CS-TYPE

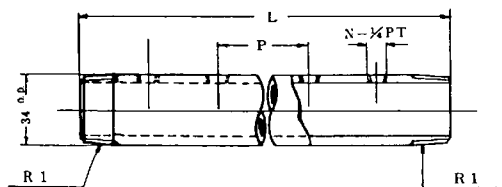

単位/mm  
Dimension in mm

型式 Type	管用ネジ Pipe thread	L	P	N
	P T			
HP-CS5	Rc NPT	260	40	5
HP-CS8	Rc NPT	380		8
HP-CS10	Rc NPT	460		10
HP-CS13	Rc NPT	580		13
HP-CS15	Rc NPT	660		15
HP-CS18	Rc NPT	780		18
HP-CS20	Rc NPT	860		20
HP-CS23	Rc NPT	980		23
HP-CS25	Rc NPT	1060		25

## HP-AW-TYPE

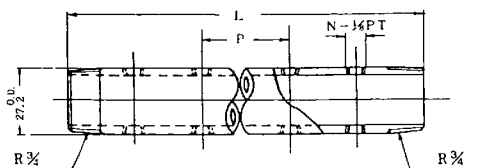

単位/mm  
Dimension in mm

型式 Type	管用ネジ Pipe thread	L	P	N
	P T			
HP-AW4	Rc NPT	130	30	4
HP-AW6	Rc NPT	160		6
HP-AW8	Rc NPT	190		8
HP-AW10	Rc NPT	220		10
HP-AW12	Rc NPT	250		12
HP-AW14	Rc NPT	280		14
HP-AW16	Rc NPT	310		16
HP-AW18	Rc NPT	340		18
HP-AW20	Rc NPT	370		20

## JBH-AS-TYPE

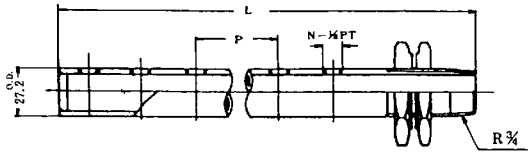
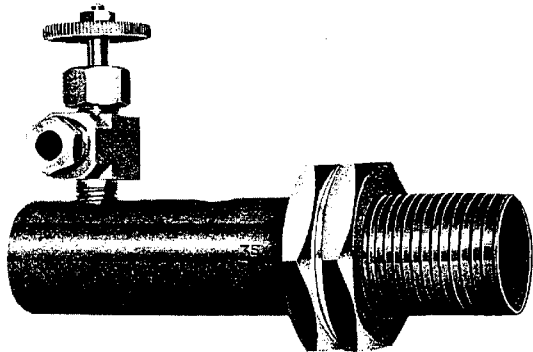

※ ヘッダーにはミニチュアバルブ類を含まぬものを標準とします。

※ HEADER items are not attached with Miniature Valves as our standard.

単位/mm  
Dimension in mm

型 式 Type	管用ネジ Pipe thread	L	P	N
	P T			
JBH-AS 2	Rc NPT	120	30	2
JBH-AS 3	Rc NPT	150		3
JBH-AS 4	Rc NPT	180		4
JBH-AS 5	Rc NPT	210		5
JBH-AS 6	Rc NPT	240		6
JBH-AS 7	Rc NPT	270		7
JBH-AS 8	Rc NPT	300		8
JBH-AS 9	Rc NPT	330		9
JBH-AS 10	Rc NPT	360		10
JBH-AS 11	Rc NPT	390		11
JBH-AS 12	Rc NPT	420		12

## JBH-BS-TYPE

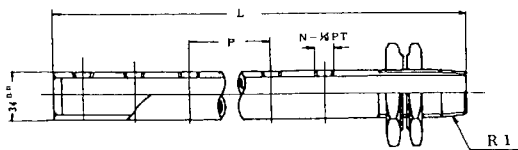
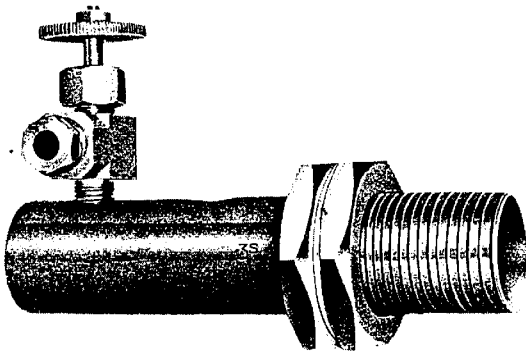

※ ヘッダーにはミニチュアバルブ類を含まぬものを標準とします。

※ HEADER items are not attached with Miniature Valves as our standard.

単位/mm  
Dimension in mm

型 式 Type	管用ネジ Pipe thread	L	P	N
	P T			
JBH-BS 5	Rc NPT	230	30	5
JBH-BS 8	Rc NPT	320		8
JBH-BS 10	Rc NPT	380		10
JBH-BS 13	Rc NPT	470		13
JBH-BS 15	Rc NPT	530		15
JBH-BS 18	Rc NPT	620		18
JBH-BS 20	Rc NPT	680		20
JBH-BS 23	Rc NPT	770		23
JBH-BS 25	Rc NPT	830		25

## JBH-CS-TYPE

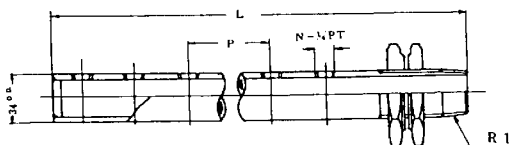
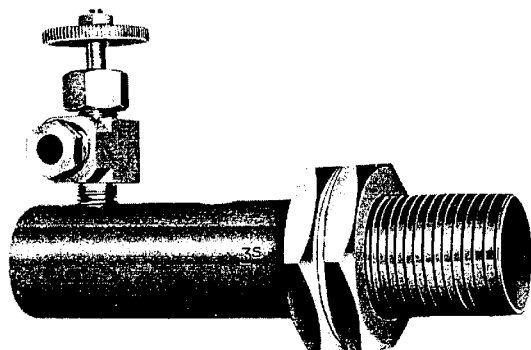

※ ヘッダーにはミニチュアバルブ類を含まぬものを標準とします。

※ HEADER items are not attached with Miniature Valves as our standard.

単位/mm  
Dimension in mm

型 式 Type	管用ネジ Pipe thread	L	P	N
	P T			
JBH-CS5	Rc NPT	270	40	5
JBH-CS8	Rc NPT	390		8
JBH-CS10	Rc NPT	470		10
JBH-CS13	Rc NPT	590		13
JBH-CS15	Rc NPT	670		15
JBH-CS18	Rc NPT	790		18
JBH-CS20	Rc NPT	870		20
JBH-CS23	Rc NPT	990		23
JBH-CS25	Rc NPT	1070		25

## JBH-AW-TYPE

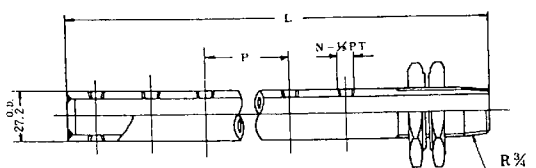
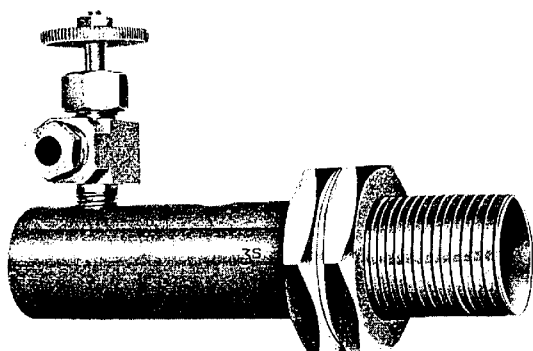

※ ヘッダーにはミニチュアバルブ類を含まぬものを標準とします。

※ HEADER items are not attached with Miniature Valves as our standard.

単位/mm  
Dimension in mm

型 式 Type	管用ネジ Pipe thread	L	P	N
	P T			
JBH-AW4	Rc NPT	120	30	4
JBH-AW6	Rc NPT	150		6
JBH-AW8	Rc NPT	180		8
JBH-AW10	Rc NPT	210		10
JBH-AW12	Rc NPT	240		12
JBH-AW14	Rc NPT	270		14
JBH-AW16	Rc NPT	300		16
JBH-AW18	Rc NPT	330		18
JBH-AW20	Rc NPT	360		20

## JBH-BW-TYPE

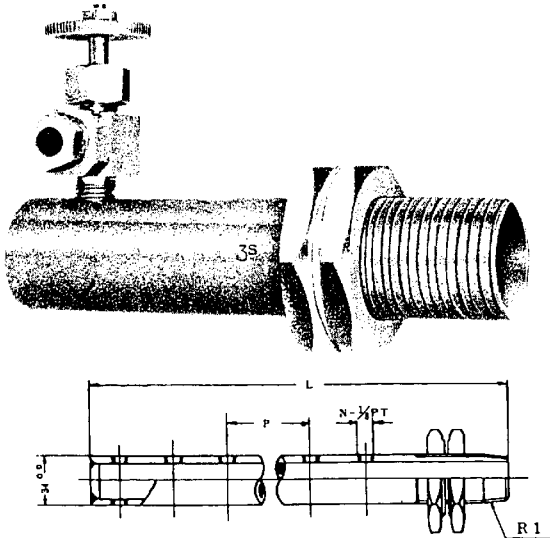

単位/mm  
Dimension in mm

型 式 Type	管用ネジ Pipe thread	L	P	N
	P T			
JBH-BW10	Rc N P T	230	30	10
JBH-BW16	Rc N P T	320		16
JBH-BW20	Rc N P T	380		20
JBH-BW26	Rc N P T	470		26
JBH-BW30	Rc N P T	530		30
JBH-BW36	Rc N P T	620		36
JBH-BW40	Rc N P T	680		40
JBH-BW46	Rc N P T	770		46
JBH-BW50	Rc N P T	830		50

※ ヘッダーにはミニチュアバルブ類を含まぬものを標準とします。

※ HEADER items are not attached with Miniature Valves as our standard.

## JBH-CW-TYPE

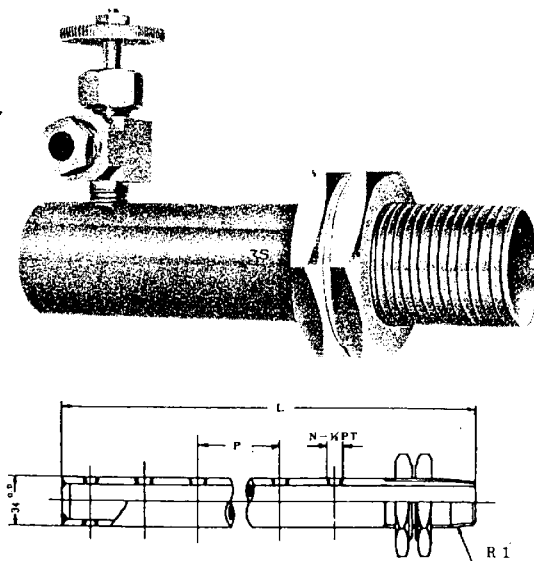

単位/mm  
Dimension in mm

型 式 Type	管用ネジ Pipe thread	L	P	N
	P T			
JBH-CW10	Rc N P T	270	40	10
JBH-CW16	Rc N P T	390		16
JBH-CW20	Rc N P T	470		20
JBH-CW26	Rc N P T	590		26
JBH-CW30	Rc N P T	670		30
JBH-CW36	Rc N P T	790		36
JBH-CW40	Rc N P T	870		40
JBH-CW46	Rc N P T	990		46
JBH-CW50	Rc N P T	1070		50

※ ヘッダーにはミニチュアバルブ類を含まぬものを標準とします。

※ HEADER items are not attached with Miniature Valves as our standard.